

MAGICSTEEL



KAJA MAGICSTEEL Single-lever sink mixer DN10 Stainless steel

flow rate A
output 13 l/min
at 3 bar flow pressure

with swivel-spout,
extension 195 mm, aerator,
flexible connection hoses,
mixing cartridge with ceramic-discs,
material: stainless steel

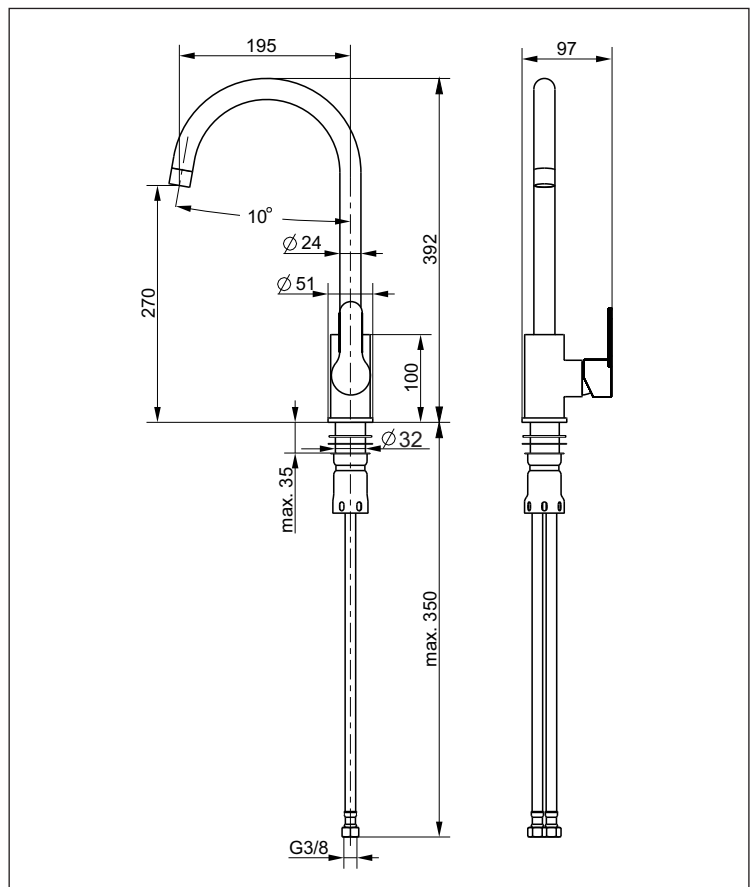

finish	code
stainless steel matt brushed	53820-ES